

HOLMAN

Misting Kit

25m with Misting Timer



PACKAGE CONTENTS

25m Misting Hose	1x Misting Filter
24x Misting Tees with Brass Nozzle	6x Hose Joiners
5x Misting Elbows with Brass Nozzle	5x Tee Joiners
1x Misting Tee	5x Elbow Joiners
1x Misting Elbow	1x Auto Drain Valve
1x Universal Tap Adaptor	35x Hose Clamps
2x Brass Nozzles	1x Pipe Cutter

Instruction Manual

Product Code: MK21025

Note: Flush Misting System thoroughly before attaching misting nozzles to prevent blockages.

Scan the QR Code on the right to see more information on the Misting System - including a product guide video.



1. Outdoor Cooling Misting System.....	p1
2. The Way It Works.....	p1
3. Glossary.....	p2
4. Misting System Assembly & Installation...p3	
A. Plan Your Misting Installation.....	p3
B. Water Supply.....	p3
C. Positioning Misting Jets.....	p4
D. Installing The Fittings.....	p5
E. Installing The Misting System.....	p6-7
F. Flushing The System.....	p8
G. Water Filter.....	p8
H. Auto Drain Valve.....	p8
5. Maintenance Of Your Misting System.....	p9
6. Troubleshooting.....	p9
7. Warranty.....	Back Page

PLEASE READ INSTRUCTION MANUAL BEFORE USE

The Holman Misting system features 7mm diameter high pressure tubing with “compression fittings” that are made to match this tubing. The compression fittings fit the pipe very precisely and simply push over the pipe and are very easy to assemble. No clamps are required. Please note that your misting system can be expanded with more Holman misting parts. These are available at your Holman stockist.

The Way It Works

The misting system cools the air temperature by the evaporation of the fine particles of water emitted by the misting nozzles. The process of evaporation absorbs heat from the air and cools the area. The misting nozzle emits very small amounts of water. It also breaks the water into very small droplets or a “mist”.

In hot conditions, the small water droplets evaporate almost instantaneously. In cooler or humid conditions the evaporation rate may be slower. Generally, you will not want to run the misting systems continuously. If you do, the general environment may become damp and unpleasant. The simple way to solve this problem is to use a Holman Misting Timer.

This timer can be programmed to suit the environmental conditions of the day. You can easily adjust the “ON” time (in seconds) and the “OFF” time (in seconds or minutes) and the misting system will automatically turn on and off as you desire.



PACKAGE CONTENTS

- | | |
|--|-------------------------|
| 1. 25m Misting Hose | 8. 1x Misting Filter |
| 2. 24x Misting Tees with Brass Nozzle | 9. 6x Hose Joiners |
| 3. 5x Misting Elbows with Brass Nozzle | 10. 5x Tee Joiners |
| 4. 1x Misting Tee | 11. 5x Elbow Joiners |
| 5. 1x Misting Elbow | 12. 1x Auto Drain Valve |
| 6. 1x Universal Tap Adaptor | 13. 35x Hose Clamps |
| 7. 2x Brass Nozzle | 14. 1x Pipe Cutter |

A. Plan Your Misting Installation

Take 5 minutes to work out how you will run the misting pipe-work and where you should position the misting jets, where your water source will come from and where the supply pipeline will run.

The general idea is to position the jets to create a “mist curtain” surrounding your outdoor entertainment area. It is best to position the jets away from tables and chairs, and where people may sit as the jets may at times drip water. You do need to work out what you can attach the pipe-work to and plan a route that makes attaching the pipe-work easy.

B. Water Supply

The misting system uses very little water volume. Each jet uses 2 litres an hour. The misting system works best when you have a high pressure water supply. The higher the pressure the finer the water droplet and the quicker and more effectively the droplet evaporates and cools the area. A normal household water supply is usually at an adequate pressure.

The misting pipe can be connected directly to a garden tap. Only fresh tap water is suggested as bore or dam water may contain sediment that will block the jets. You can use a garden hose to bring water from a tap in the area to the start of the misting pipe-work. If the hose is running in the sun, please ensure it is a good quality hose that will be able to withstand the pressure when the water and hose may get heated. (See page 6 for Garden Hose connection)



HINT: If you want to easily maintain the use of the garden tap for other uses, install a Holman 2 way or 4 way manifold and fit the misting system to one outlet.

C. Positioning Misting Jets

Factors to consider are: -

- Spacing of jets.
- Location of jets over tables or chairs.
- How many jets in a particular area.

There are no fixed rules to how you position the jets.

The more jets you have, the more water you will use and potentially the cooler the space will become.

However, too much water can be a problem because the air can become saturated and even wet the people and objects in the space.

Holman recommend the following:

- Space jets between 600mm and 1 metre apart.

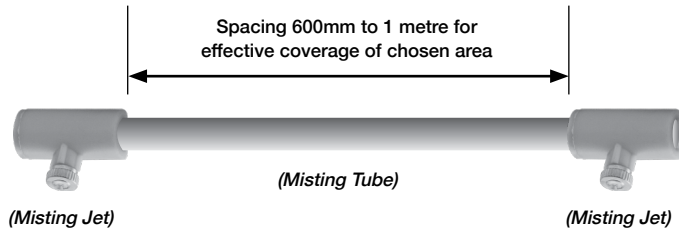

- Locate jets away from tables and sitting areas if possible.
 - Try and create a curtain of mist at least on two sides of the area being cooled.
 - Install a Holman misting timer. This will allow you to regulate the amount of water entering a space by adjusting the "ON" times and "OFF" times of the timer. You would have more "ON" time on a hot dry day than a cooler moister day.
- The HOLMAN misting timer allows you to make these settings in seconds, where other timers may not have this feature.

D. Installing The Fittings

The Holman Misting System features "compression fittings".

These fittings feature a compression ring that grips the tube and prevents it coming loose or leaking water.

The higher the pressure the better the compression fittings hold onto the tube.

To ensure a good joint, the tube must be cut "square" and "burr free".

The best way to achieve this result is to use the Holman misting tube cutter. This ensures a clean square cut. It is also very quick to use. *(Holman Misting Tube Cutter sold separately - Product Code: MS20011)*

Once the tube is cut the compression fitting is very simply installed.

- Bring the 2 parts together, level and straight.

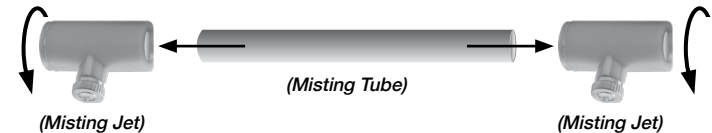

- Push the tube in while twisting the fitting a little.

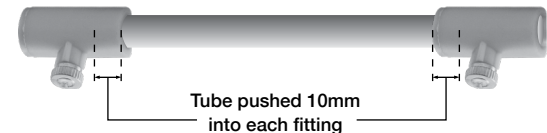

- The tube should enter the fitting at least 10mm. Once tubing is installed it cannot be removed from the elbow, tee or joiner.

E. Installing The Misting System

Each section of tube should be connected before attempting to pin the system to walls or beams. Start at the garden tap or water source point. If you are using a Garden Hose (A), it is recommended that you install a **Sprinkler Adaptor (C)** into the **Misting Filter (8)** as shown. Run the tube to the position you want your first misting jet in. Use **Tees** or **Elbows** to go around corners or split the pipe runs. Visit www.holmanindustries.com.au for more info on our sprinkler adaptors

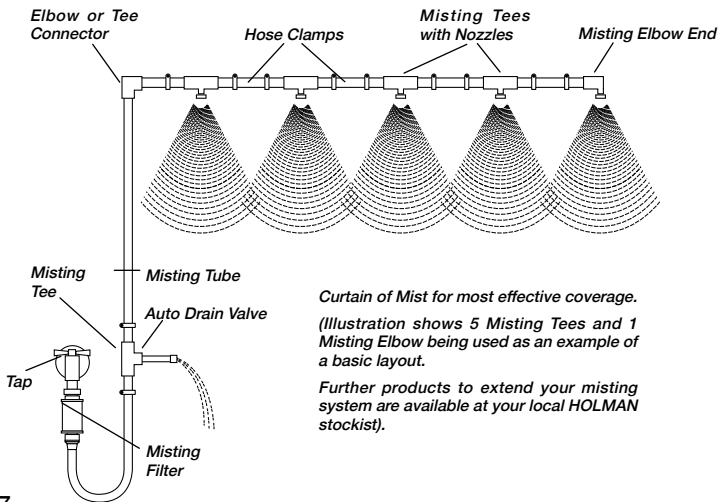
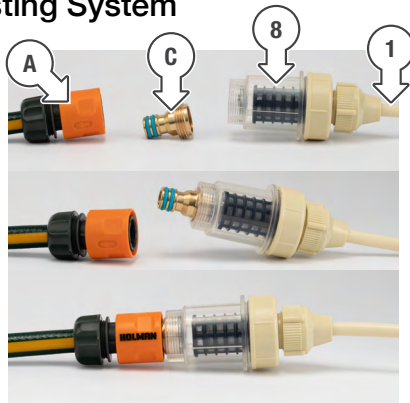

Curtain of Mist for most effective coverage. (Illustration shows 5 Misting Tees and 1 Misting Elbow being used as an example of a basic layout.

Further products to extend your misting system are available at your local HOLMAN stockist).

Work out the spacing of the misting jets and cut the misting hose to length and install the relevant misting tees. Finish each line with a misting elbow.

(3 x Misting Elbows are included in this System to enable installation of a single or multiple line misting solution. More Misting Elbows are available at your nearest HOLMAN stockist Product Code: MS20003)

Use the hose clamps to attach the misting hose to the wall or beams.

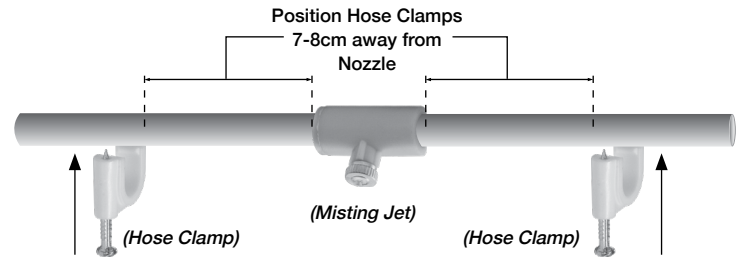

The Holman hose clamps use a very strong masonry nail that should not bend when you hammer it into timber or masonry.

HINT 1: Run pipework along mortar joints in brickwork. Hammer the hose clamps into the brickwork for a reliable result.

HINT 2: Use a hose clamp on each side of a misting tee to ensure the tee is firmly positioned and misting in the correct direction.

HINT 3: If hammering into metal the correct nails will need to be purchased.

HINT 4: Avoid installing the tube in direct sunlight as this may cause the tube to go brittle over time.

F. Flushing The System

Perhaps the most important part of the installation process is to properly flush the system.

Remove ALL JETS and then connect the water and run for 4 or 5 minutes. This will ensure that all dirt and pipe swarf is flushed from the system. If this is not done, the brass jets will clog up and then they will not work correctly.

The hole size in the brass jets is extremely small. It is like this to ensure that the water particle is very small – like a mist.

G. Water Filter

Because the principle of evaporative cooling relies on very small volumes of water evaporating and absorbing the ambient heat, it is critical that the water entering the misting system is very clean and free of all particles that will not pass through the very small hole in the misting jet.

It is highly recommended that the filter be installed immediately after the connection to the water source.

From time to time it may be necessary to clean the filter. This is best done by using cleaning solution like vinegar. This is available at your hardware store.

This will not only assist clean solid particles away, but it will dissolve calcium and iron deposits that build up as water evaporates in the filter (and jets).

H. Auto Drain Valve

This is a very important component in your misting system.

This should be installed at a low point in the system.

This valve will automatically release the pressure in the line and then “dump” the water in the misting hose “above” the level of the auto drain valve when the water is turned off. *It is important to note that the Auto Drain Valve should be positioned where water can run freely, ie. Into a drain or garden area.*

This is important to stop the misting jets from “dripping” and “dribbling” and also stops the build up in precipitated salts (like calcium and iron) from the water.

Do not remove the end of Auto Drain Valve unless blocked. There is a very small ball inside and if opened the ball will fall out.

5. Maintenance Of Your Misting System

Please use these hints to keep your misting system operational and prevent unnecessary clogging of the misting jets: -

1) *Drain Water from your System*

When your system is not in use, drain all water from your system. If you use an automatic draining valve, this job will happen automatically.

2) *Clean Nozzles*

Periodically clean all nozzles by soaking them in a solution of vinegar, or similar calcium and iron remover.

3) *Flush System*

Periodically remove all nozzles and flush the system by running water through it for 4 or 5 minutes.

4) *Clean Filter*

Periodically clean the filter by soaking in a solution of vinegar to remove calcium and iron build up.

6. Troubleshooting

1) *Disassemble System*

If you need to disassemble the system this can be done.

The best way to remove compression fittings from the misting hose is to “wobble” them from side to side while pulling them apart

If the misting hose is damaged in this action, cut it off before the compressor fitting is re-installed.

2) *Clean Nozzles*

If nozzles are “dripping” or not “misting” properly, they must be removed and soaked in cleaning solution like vinegar. If this fails to clean the jet, it is highly recommended to purchase replacement jets and replace all jets as required.



**Thanks for being a
#SMARTGARDENER**

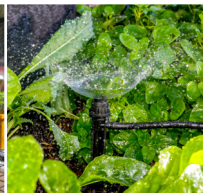
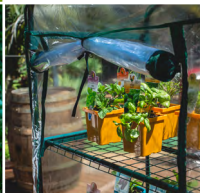

**We really appreciate having you as a customer,
and would like to say thank you for choosing us.**

We recommend registering your new product on our website. This will ensure we have a copy of your purchase and activate an extended warranty. Keep up to date to with relevant product information and special offers available through our newsletter.



www.holmanindustries.com.au/product-registration/

HOLMAN

For the #SMARTGARDENER   